

MODEL 3412AS-PE, 3414AS-PE

Quality control department **SAFETY FIRST** - Always use cave in protection, gloves, sturdy work boots and eye protection when tapping pipe

GENERAL NOTES:

- Use cave-in protection during excavation and back-fill operations.
- Verify Pipe O.D. to make certain that the correct Service Saddle is being installed.
- Keep bolt threads clean and free from nicks, dents or other damage.
- If conditions permit, mark the pipe for a reference point to properly position the Saddle.
- Lubrication of the O-ring with a soap solution reduces friction and more evenly distributes clamping force. For cold weather lubrication, ethylene glycol can be added to the soap solution to prevent freezing.

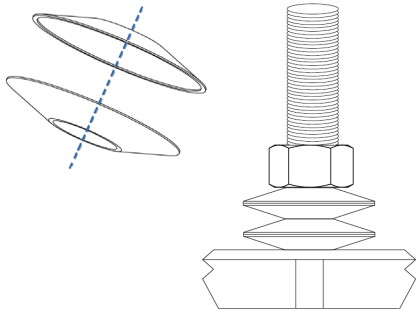

1 Check pipe diameter to insure that correct saddle is being installed.



2 Thoroughly clean the pipe so surface is smooth and free of dirty and other debris.



3 Loosen nuts until flush with top of studs, and place saddle around pipe.



4 Close lug fingers and studs together by pulling the washer bar upward and snap the lip over the finger base plate. Finger tighten nuts.



5 Locate outlet in desired position.

RECOMMENDED TORQUE	
Bolt Diameter	Torque (ft-lb)
5/8"	50-70

Waterworks pipes can experience changes due to temperature and pressure depending on the field conditions. High-Density Polyethylene Pipe (HDPE) possess mechanical and thermal properties that causes the expansion or contraction of the pipe because of these changes. Saddles with spring washers design will support those possible pipe changes without compromising the tightness of the saddle.

MODEL 3412AS-PE, 3414AS-PE



Quality control department SAFETY FIRST - Always use cave in protection, gloves, sturdy work boots and eye protection when tapping pipe



Torque nuts 50 to 70 ft/lbs to form a gasket seal. Do not over torque as it will not increase sealing ability and may cause plastic pipe failure.



If necessary to reposition, loosen nuts prior to moving saddle and then retorque.



Tap through corporation stop utilizing a VegaDrill for best results on plastic pipe.

9

Leave each connection exposed and field pressure test prior to backfilling to assure proper installation on the pipe.



If dry tapping follow the above, but also retorque the nuts after field testing to compensate for pipe expansion.

PRE-INSTALL CHECKLIST:

DID YOU:

- Clean pipe surface thoroughly? [Y] [N]
- Check O.D. of pipe with measuring tape? [Y] [N]
- Lubricate the Pipe with Dishwashing Soap? [Y] [N]
- Verify Proper Torque Required? [Y] [N]
- Bring the proper equipment required to support the valve during the tap? [Y] [N]

Warranty Checklist (*):

- Date of Installation __/__/__
- Time of Installation _____ [AM] [PM]
- Was Pre-Tap Pressure Test completed to appropriate pressure level? [Y] [N]
- What Pressure was it tested to? ____ psi
- (PowerSeal recommends torqueing in 25 ft-lb increments) *Torque Applied: _____ ft-lbs
- Was standard re-torqueing applied 5 minutes after reaching torque requirements? [Y] [N]
- Was an even gap between top and bottom shell maintained while torqueing the nuts in sequence? [Y] [N]
- Was the Valve Supported During Installation? [Y] [N]

If so, with what was it supported by? _____

Signature of On-Site Leadman: _____

*** Must be completed on day of installation to Validate Warranty**